

The Multi-fuel Combustion System Peko Pe

Designed for fuel and energy conservation

Energy for everyone

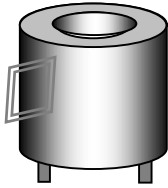

The energy unit

is the hart of the system .The unit is burning with a clear, smoke and sootless flame of about 600-700 °C with most types of combustibile dry biomass.

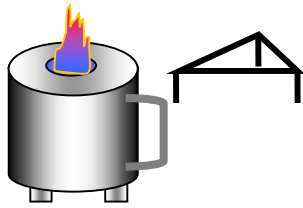

Fuel

1 kg chopped wood or briquettes will burn about 1 hour with flame, and be glowing about 2 hours. That means you will have about 3hours time of cokking

With a simple iron device on top of the unit you will be able to make a meal or heating water

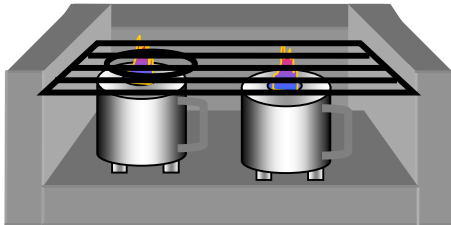

Two units arranged in a system of blocks or bricks and a grid will make it more convenient to prepare meals

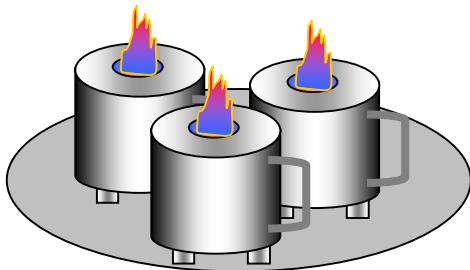

If you need more energy for big pots, wok or grill, you just put more units together then you will cover all needs of energy. To keep food warm you need only one unit
3 units with 6kg of chopped wood will bring 60 litre of water to boil within 50 minutes and continue to boil another 2 hours.

Institutional kitchens

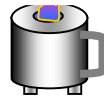
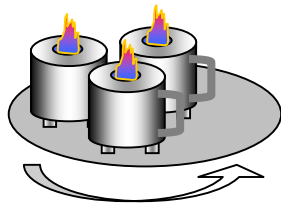

More energy units placed just under the pan or on a rotating disk, which can be regulated up and down, you will have the energy you need for any kind of cooking.

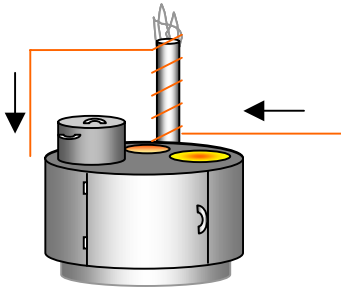
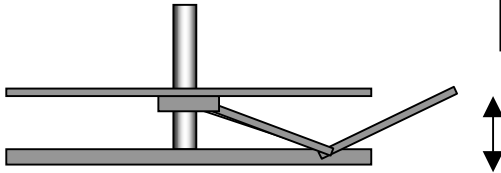

Kitchen range of any size
A water-tube placed into the exhaust-pipe and connected to the water-pressure system

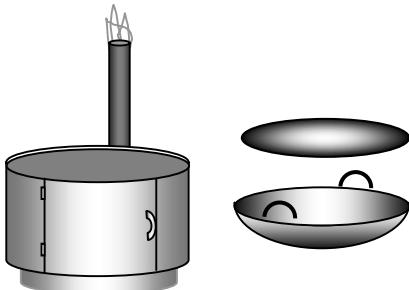

Griddle or large wok can be replaced on top of the range

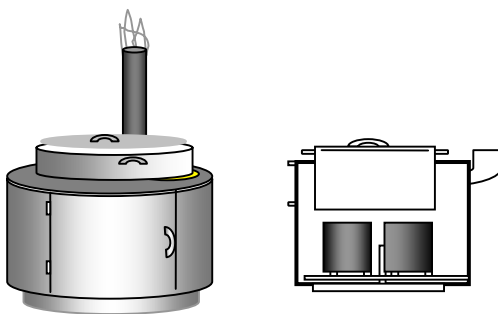

Boiling large pans with more energy-units

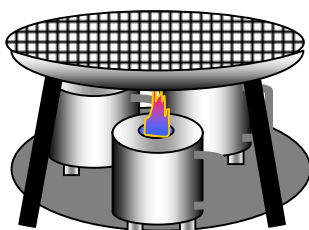

The system do not need any chimney, but good ventilation.

